

Clip and fit

A full range of Aluminium profiles with sliding clip **TO FIX FASTLY AND EASILY PANELS AND MIRRORS**

- All kinds of fitting possibilities
- Faster measurement taking and installation
- Provides a margin of more than 15 mm of allowance
- Avoids errors, lessens the risk of breakage during assembly
- Decorative, with perfect finishes
- Pre milled and ready to bore
- For all panels and mirrors from 3 to 8 mm



Range R 800 Clip

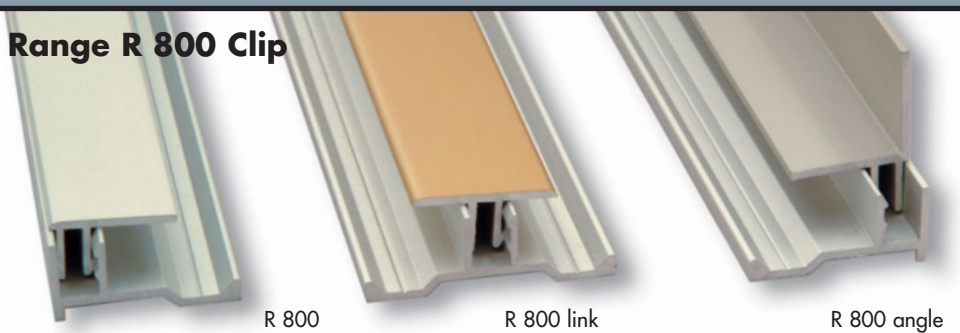

R 800

R 800 link

R 800 angle



R 800 plinthe

Range R 600 Clip



R 600

R 600 link

R 600 angle

NEW

Range F 400

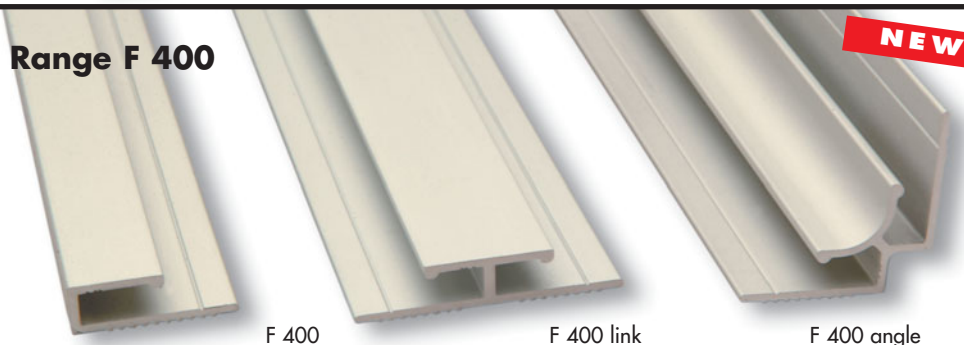

F 400

F 400 link

F 400 angle

NEW

• Finishes

Natural anodized (silver aspect)

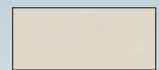

Polished Gold 4, (brass aspect)

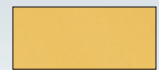

Polished C31 (stainless steel aspect)

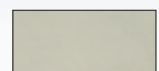

Range R 800 Clip

Recommended for panels from 7 to 8 mm and mirrors of 6 mm

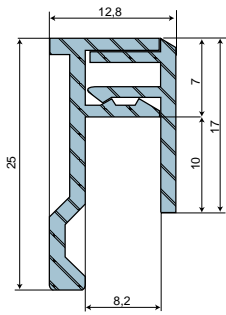

R 800

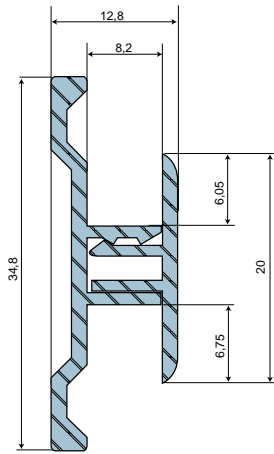

R 800 link

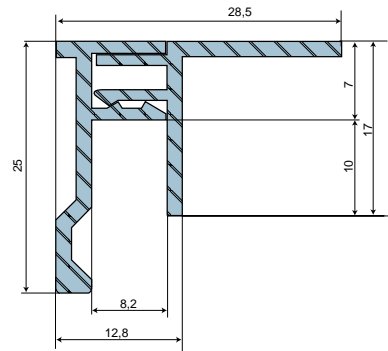

R 800 angle

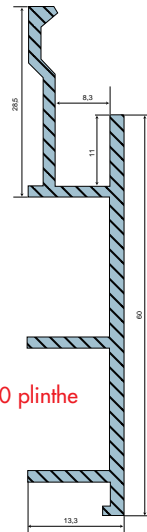

R 800 plinthe

Range R 600 Clip

Recommended for panels from 5 to 6 mm and mirrors of 4 and 5 mm

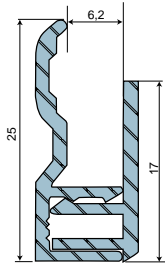

R 600

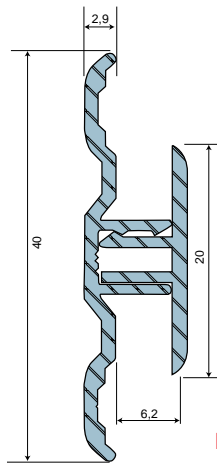

R 600 link

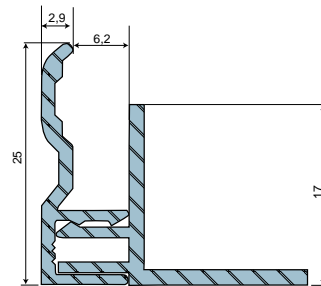

R 600 angle

Range F 400

Recommended for panels from 3 to 4 mm and mirrors of 3 mm

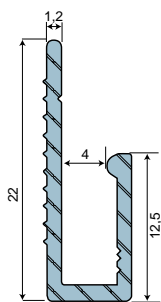

F 400

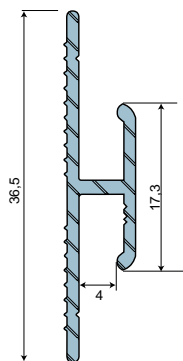

F 400 link

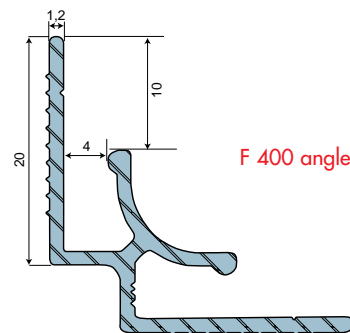

F 400 angle

Clip and fit

Quality references

- Aluminium alloy 6060 T5 ISO 9001
- Anodized EWA norm A9-450 Patented (SGDG european)



CLIPPER DIFFUSION

Domaine de la Bayone
avenue du Club Hippique
13090 Aix en Provence - France

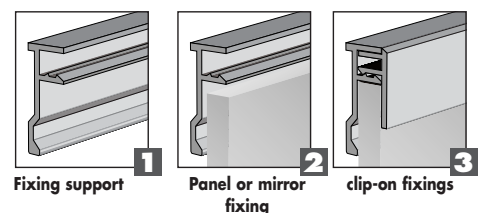

info@clipalu.com

www.clipalu.com

Tel. (+34) 932 405 878
Fax. (+34) 932 405 879
Mobile. (+34) 667 984 808